



## The Unit

Before installing the unit check the packaging contains the Unit, mounting components, and a CD, and the Hardware code and Configuration code to ensure that it is suitable for the process specified.

### TO MOUNT THE UNIT

The Unit is supplied as two parts, the controller and the sleeve, but is intended to be mounted together through a cut out in the front panel of an electrical control cabinet. It is held in position using the panel retaining clips supplied.

The Unit can be mounted vertically or on a sloping panel of maximum thickness 15mm (0.6 inches). Adequate access space must be available at the rear of the instrument panel for wiring and servicing purposes.

*Note. Once mounted, the Controller may be removed from the sleeve at any time.*

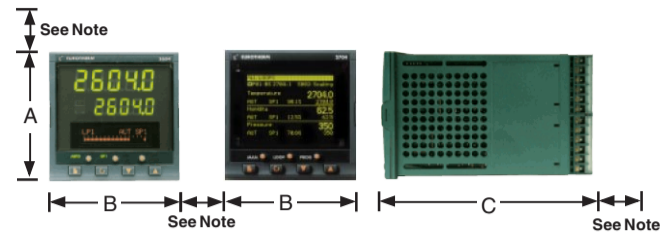

*Note. Always allow sufficient clearance for ventilation and connections.*

Dimension	Measurement
A	96 mm (3.78 Inches)
B	96 mm (3.78 Inches)
C	150 mm (5.91 Inches)

### DIRECT PANEL MOUNTING

- Check that the mounting panel is not thicker than 15mm (0.6 inches) (typically for wood or plastic) and not thinner than 2mm (0.08") (for steel).
- In the mounting panel, cut an aperture 92mm x 92mm (+.8mm).

Panel cutout  
92mm x 92mm  
(+ .8mm)  
(3.62" x 3.62"  
(+0.03"))

*Note. Ensure the Unit is not mounted close to any device that is likely to produce enough heat to affect the performance.*

- Insert the Unit through the panel cut out.
- Spring the upper and lower panel retaining clips into place. Secure the unit by holding it level and pushing both retaining clips forward.

Once fitted this unit is IP65 rated.

*Note. If removing the retaining clips, unhook the side using fingers or a screwdriver, and extract (slide) the unit from the mounting panel.*

### REMOVING THE CONTROLLER

The controller can be removed from the sleeve by easing the latching ears on either side of the sleeve outwards and pulling the controller forward. When fitting the controller back into the sleeve, ensure the latching ears click into place.

### Warning

For safety reasons and to prevent premature wear on the connectors the Power to the Unit MUST be isolated before removing the Controller.

Environmental Requirements	Minimum	Maximum
Temperature	0°C	50°C
Humidity (Relative - RH)	5% RH	95% RH
Altitude		2000m

## Plug-in I/O Modules

Use 4-terminal I/O modules at Module 1, 3, 4, 5, and 6 only, except where stated.

*Note. Check the order code on the side of the unit, to learn what modules are fitted, and use 'View Config' level to inspect each Module position. Any changes to the Modules Position should be recorded on the side of the unit.*

### OUTPUT TYPES

2-pin (R2) or Dual Relay (RR)

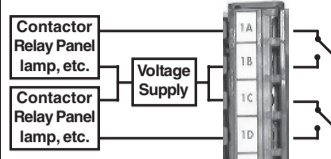

Change Over Relay (R4)

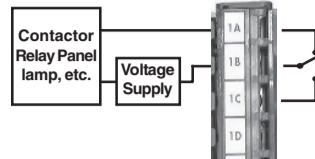

*Note. Both Relays support 264Vac, 2A max, 12V, 10mA min.*

Triac (T2) and Dual Triac (TT)

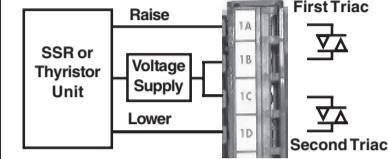

*Notes Triac and Dual Triac*

- The combined current rating for the Dual Triacs must not exceed 0.7A, 30 - 264Vac.
- Dual Relay modules can be configured to offer the same control as the Dual Triac.

DC Control (D4) or DC Re-Transmission (D6)

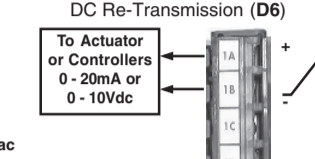

*Note. Wire to Actuators for DC Control, and to Controllers for DC Re-Transmission.*

Dual DC Output (DO)

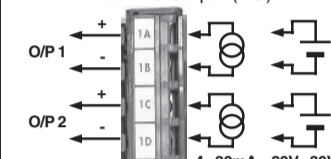

*Notes Dual DC Output*

- Supports 4 - 20mA or 24Vdc power supply.
- Fit in Module positions, 1, 4, and 5 only.

High Resolution DC Output (HR)

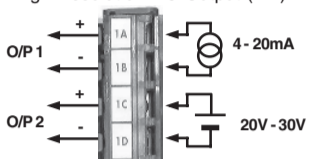

*Notes High Resolution Dual DC Output*

- Supports one 15-bit 4 - 20mA and one 24Vdc power supply per channel.
- Fit in Module positions, 1, 4, and 5 only.

Isolated Single Logic (LO)

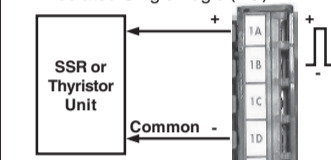

*Note. Isolated Single Logic Output supports 18Vdc, @ 24mA max, per channel.*

Isolated Triple Logic (TP)

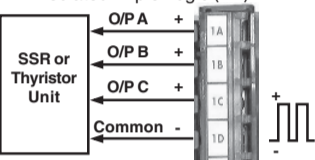

*Note. Isolated Triple Logic Output supports 18Vdc, @ 8mA max, per channel.*

### POWER

24V Transmitter Output (MS)

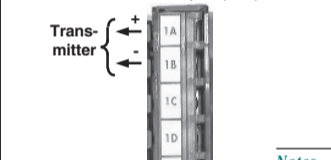

*Note. 20mA to external transmitter.*

Transducer Power Supply Output (G3 or G5)

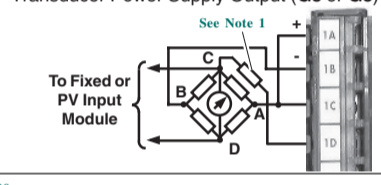

*Notes*

- Fit an external calibration resistor if not already installed.
- Use screened cable to reduce interference for Strain Gauge power supply connections.
- Uses 5 or 10Vdc to power Strain Gauge Transducer
- Uses Shunt Contact for automatic calibration.

## INPUT TYPES

These support both PV (PV), Module positions 3 and 6 only, and Analogue Input (AM) Modules, any position except Module position 5.

Voltage (V) (0V to 10V or 0V to 2V) Milli-volts (mV) (up to 100mV) Current (mA) (0mA to 20mA or 4mA to 20mA) Thermocouple or Pyrometer 2-, 3-wire PRT

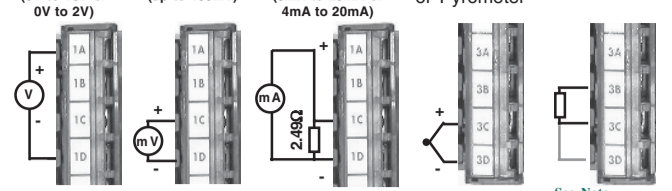

*Note. If using 2-wire PRT, fit link between C and D.*

These support PV Input (PV) Modules, restricted to Module positions 3 and 6. Zirconia Probe Dual PV Input (DP) Zirconia Probe 2 PV Input Modules (PV) Dual PV Input (DP) (Current source)

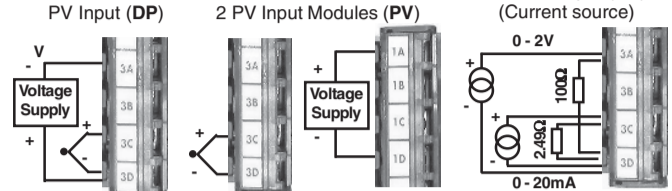

*Note. Wire Voltage Supply to any Input.*

*Note. Common connections to D, must be returned to D separately.*

4-wire PRT (PH or PL)

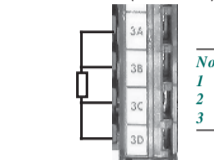

*Notes*

- If runs exceed 30 metres use screened cables.
- Ensure the resistance of each wire is the same.
- PH version uses 100Ω, PL version uses 25.5Ω.

These support Digital and Potentiometer Input Modules fitted in any position. Triple Logic Input (TL) Triple Contact Input (TK) Potentiometer Input (VU)

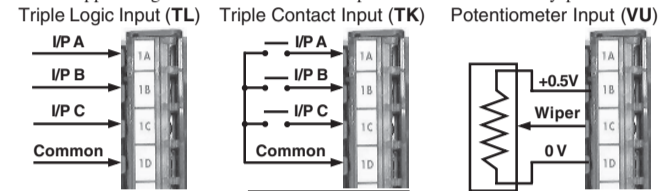

*Note. <5V Off, >10.8V On. Limits: -3V, +30V.*

*Note. <100Ω On, >28KΩ V Off.*

*Note. 100Ω to 15KΩ range.*

### TDS MODULE (2704 ONLY)

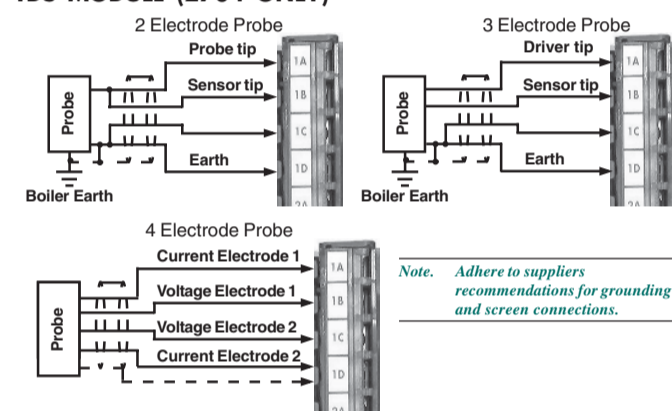

*Note. Adhere to suppliers recommendations for grounding and screen connections.*

## Communications - DeviceNet™

Protocol is DeviceNet™ interface requiring each node to have a unique address on the DeviceNet™ network and must be set to the same Baud rate.

*Note. Refer to DeviceNet™ Communications Handbook, Part No. HA027506ENG.*

Legend	CAN Label	Chip Colour	Description
HA	V+	Red	DeviceNet™ network power positive terminal.
HB	CAN_H	White	DeviceNet™ CAN_H data bus terminal.
HC	DRAIN	None	Shield/Drain wire connection. To prevent ground loops, the DeviceNet™ network should be grounded in only one location.
HD	CAN_L	Blue	DeviceNet™ CAN_L data bus terminal.
HE	V-	Black	DeviceNet™ network power negative terminal.
HF	-	-	Connect to instrument earth.

### Caution

Power Taps are recommended if connecting a DC power supply to the DeviceNet trunk line. To connect multiple Power supplies, fit a Schottky diode to the V+ of each Power Supply unit. Connect 2 fuses or Circuit Breakers to protect the Bus from excessive current, that may cause damage to the cables and connectors. Connect the Instrument Earth terminal, HF, to the main Power supply earth terminal.

### WIRING

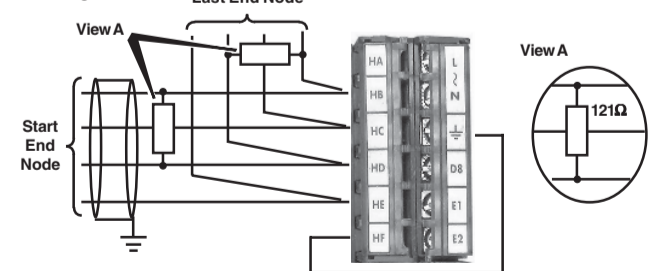

### TERMINATION RESISTOR

A 121Ω Termination Resistor must not be fitted as any part of a master or slave if already internally installed.

## Communications - Profibus™

Protocol is Profibus DP requiring each node to have a unique address on the Profibus network and must be set to the same Baud rate.

*Note. Refer to Profibus™ Communications Handbook, Part No. HA026290.*

Legend	Signal	9 Pin D Type	Description
HA			N/A
HB	Shield	1	Shield/Drain wire connection.
HC	VP (+5V)	6	5V supply
HD	Rx/Tx (+ve)	3	Profibus network power positive terminal.
HE	Rx/Tx (-ve)	8	Profibus network power negative terminal.
HF	Dig Grnd	5	Digital Ground.

### WIRING

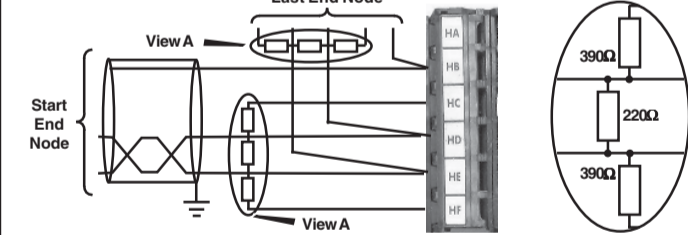

Use standard ProfiBus cables, 'Line A' and 'Line B', with special 9 pin D Type male connector headers, allowing one or two cables to be fitted. A termination load is built in with an ON/OFF switch, set to ON at the two ends of the line. When using 9 pin D Type connections a further assembly is required.

### TERMINATION RESISTOR

The Profibus specification states that the Termination Resistor must be fitted to the last nodes in the line.

## Communications - Modbus/TCP

Protocol is Modbus/TCP, 10 Base T on an Ethernet network.

*Note. Supported by the 2704 Unit only.*

This requires an additional connector, Part no. SUB27/EA. It connects to the HA to HF terminals and allows communications via standard CAT5 cables directly to a Computer or Ethernet Switching unit/Hub.

*Note. A cross-over cable MUST be used if connecting directly to a Computer operating as a Network master.*

RJ45 Pin	Colour	Signal
8	Brown	N/A
7	Brown/White	N/A
6	Green	Rx-
5	Blue/White	N/A
4	Blue	N/A
3	Green/White	Rx+
2	Orange	Tx-
1	Orange/White	Tx+

Plug shroud to Cable screen

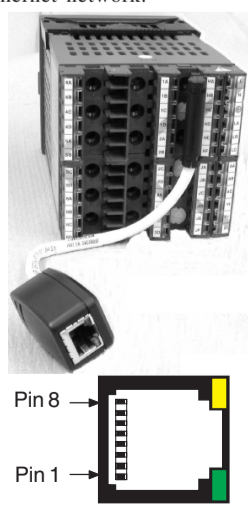

## Communications - Modbus

Protocol is Modbus RTU, EIA232, EIA485 3-wire or 5-wire.

*Note. Refer to 2000 Series Communications Manual, Part No. HA026230.*

The Modbus network connection is via the HA to HF and JA to JF terminal connections. Units MUST be connected in a daisy-chain method using twisted pair cable.

*Note. The Screen from each cable should be connected through and grounded at one point only.*

Legend	EIA232	EIA485 3-wire	EIA485 5-wire
HA (JA)	N/A	N/A	N/A
HB (JB)	N/A	N/A	Rx+
HC (JC)	N/A	N/A	Rx-
HD (JD)	Com	Com	Com
HE (JE)	Rx	A	Tx+
HF (JF)	Tx	B	Tx-

*Note. Alternatively, use the JA to JF terminals.*

### EIA232

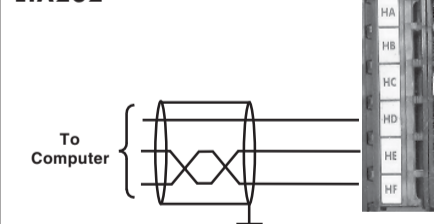

### EIA485 3-WIRE

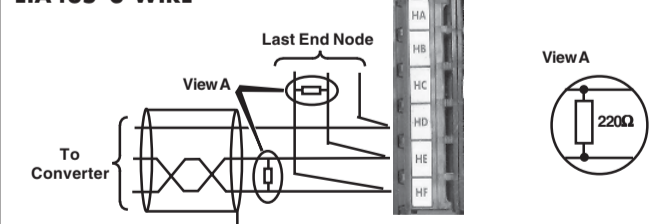

### EIA485 5-WIRE

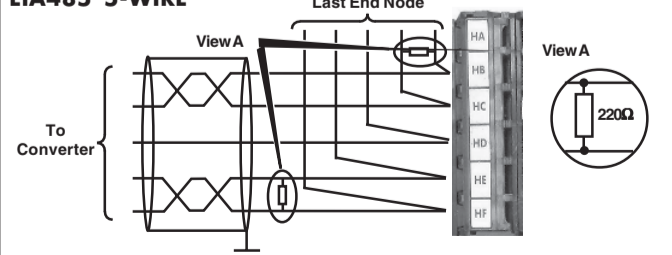

*Notes EIA485*

- Use twisted pair cable throughout.
- An EIA232 to EIA485 converter is required when connecting directly to a Computer.

### TERMINATION RESISTOR

A 220Ω Termination Resistor MUST be fitted across the Receiver signals (Rx+ and Rx-) at each end of a maximum 32 communicating instruments.