

EUROTHERM FLEXIBLE SOLUTIONS

3000

SERIES CONTROLLERS...



invensys®
EUROTHERM®



...in tune with your needs

From the simplest needs...

Eurotherm®'s latest range of controllers provides our world class excellence in control with clear, user friendly operator interfaces. Quick start codes; automatic help text; custom text messages, and an auto-tune that really works ensures the 3200 range makes high performance control simple to implement and easy to operate.

With the emphasis being on simplicity and available in four standard formats, the 3200 range provides precise temperature control with a host of options. A simple 'QuickStart' code is used to configure all of the essential functions required to control your process and, if preferred, this can be preset by Eurotherm

to your requirements. When accessing the controller HMI you will find that every parameter is accompanied by a scrolling text message to describe its function.

The 3200 has a host of advanced features including heater failure detection, timer, setpoint programmer and a recipe feature that is unique in this class of product. All of these features can be configured with an extremely simple to use PC wizard configuration tool. Configurations can be saved to file and reused or modified to suit other applications in the future.

3200 Range

Easy to use

Fast initial set-up using QuickStart code

- enabling 'out of box' operation

Expert configuration by PC wizard

- On-line help explains each step

Recipes can be selected from operator interface

- easy to adapt for differing process needs

Internal timer and setpoint programming

- suitable for simple time based profiling applications

Communications

- integration with PLCs and PCs using Modbus protocol

3208



3216



3204



32h8



Quick and easy commissioning with one shot auto-tuning

- no need for expert control knowledge

Easy, comprehensive operator information with custom messages

- provides clear information of plant conditions with scrolling text

Clear alarm information

- custom alarm messages that operators understand

Heater failure detection and integral ammeter display

Instant indication of heater faults with indication of measured current

Analogue remote setpoint

Economical solution for multi-zone applications

...to powerful, advanced control

The 3508 and 3504 offer much more than temperature control - advanced features and options make them capable of small machine control. They provide flexible I/O options to control and measure a multitude of processes - temperature, carbon potential, humidity, flow, pressure, level, viscosity, additive dosing and many more. Specialist function blocks, recipe selection, setpoint programmers, maths, logic, timer functions and flexible communication options are just a few examples of what makes these instruments a key part of a total process solution.

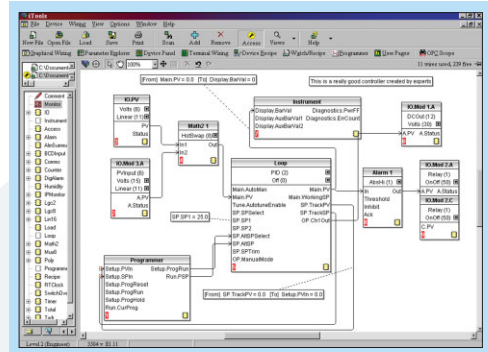

3500 Range

Technology so powerful
it's simple

3508



Dual loop

- ideal for controlling processes with two interactive variables

Precision PV measurement combined with high performance control

- repeatable performance yielding consistently high product quality

Flexible units with input and output modularity - up to 6 I/O slots with 15 different module types

- limited stock holding of same basic unit can be adapted to many different applications

QuickStart HMI configures simple applications in minutes

- faster than it takes for a PC to boot-up. Ideal for replacement of older Eurotherm products such as 818 and 902

3504



A Graphical Wiring Editor makes easy work of creating flexible solutions

- Minimum training required. Easy to document and understand applications

Easy system integration with standard industry protocols - Modbus™ RTU, Modbus™ TCP, Profibus™ and DeviceNet™

- Simple to integrate to SCADA and programmable logic controllers without expert knowledge of communication protocols

Simple and intuitive operation

- Customisable displays to clearly show the process information you need

Flexible Setpoint Programming with dual channel capability

- Up to 50 time based programs can be stored. Programs can be also be created using a PC tool then downloaded to the controller

Advanced features

- a host of maths, logic and timing features along with zirconia and humidity function blocks offer the ability to develop custom solutions and small machine controllers.

Products designed for ease of use

As well as precision PID control from the World's leading supplier, the 3000 Series controllers offer a host of features that make the units easy to use and configure to save you time and money.

QuickStart Code

A simple 10 digit code can be used to set up all of the essential 3200 functions to control your process. If you specify this code at point of order your controller will arrive pre-configured.



Configuration Wizard

Within the supporting PC based software, iTools, are configuration Wizards. These Wizards will guide you through the configuration process with interactive help and graphical demonstration of configuration options.

QuickStart HMI

Eurotherm have designed a QuickStart HMI Wizard for all of the 3500 Range controllers. In just a couple of minutes the controller can be ready for use as the wizard leads the user through all of the basic set-up via the instrument HMI. There is no need for additional tools, PCs or even an extensive knowledge of control.

Informative Displays

All of the 3000 Series displays provide clear messages and data to ensure operators get the information they need about the plant conditions. They provide, clear, complete text information with a custom message facility - (the 3200 uses scrolling text to maximise clarity for operators) - along with help text for each controller function. The 3508 and 3504 also have user-defined displays to offer views onto the process that are best suited to the operation of the plant.

Heater Failure Detection

The 3200 range can accommodate a current transformer input that can be used to monitor the status of the heaters. Normally used to provide early indication of a heater fault, this input can also be used to measure the actual current flowing and indicate the value on the front HMI, provide alarm output, or make information available to a supervisory system for power usage calculations.

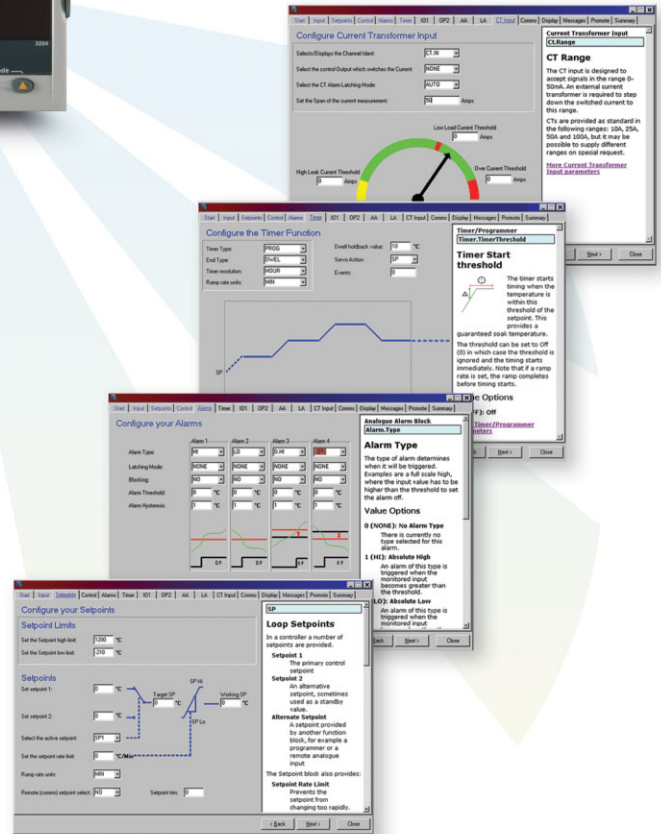

Easy Recipe Selection

Recipes can be used to change the operating parameters of the controller or even to change the full configuration - allowing one basic controller to be easily adapted to many applications. Recipes can be selected by the controller HMI using an understandable user defined name, by external hardware signals, or by digital communications.

Config adaptor

PC configuration of all 3000 Series can be achieved by using a configuration adaptor. It gives iTools the ability to communicate and configure devices without any power being connected. This device is ideal for distributors and OEMs who need to stock a wide range of options.

Flexible and Creative Solutions

Graphical Wiring Editor

The 3500 is capable of providing simple solutions to demanding applications. iTools includes a Graphical Wiring Editor to quickly implement and document such applications within the controller.

This flexible tool provides drag and drop wiring and function block placement to save time in configuration and to aid with plant diagnostics.

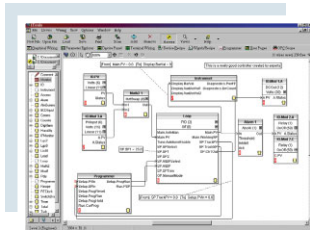

Specialist Function Blocks

The 3500 supports a comprehensive range of function blocks to provide solutions with simple configuration.

- Setpoint programmer for time based profiles - ideal for furnaces and test chambers
- Zirconia input for carbon potential control
- Wet/dry humidity measurement
- Transducer scaling - load cells, melt pressure etc
- Maths, logic and timer functions

A System Product

The 3500 is ideal for use in systems with flexible communication options to suit the architecture and integrate with other products. Its functionality with maths, logic and timers could also negate the need for a small PLC - saving money, time and space in the system.

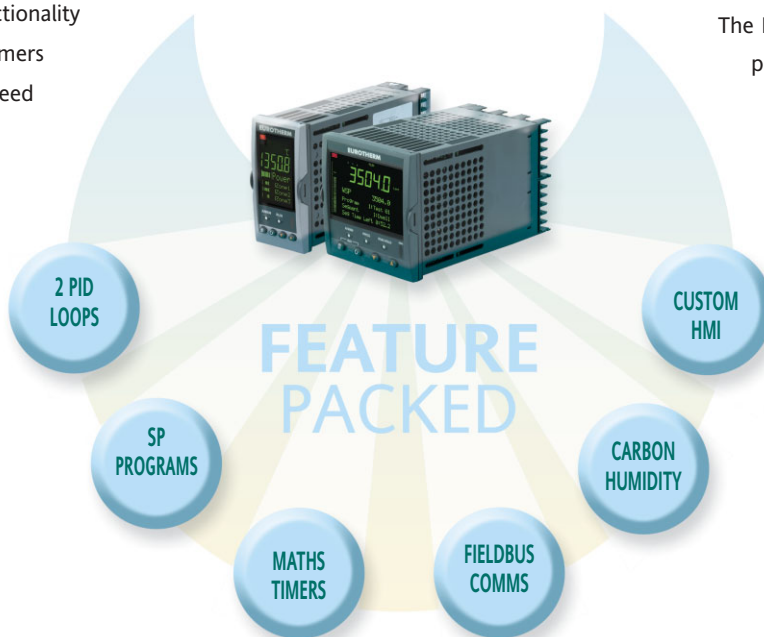

Setpoint Programming

An impressive Ramp/Soak programmer is available in the 3500. The ability to store up to 50 different programs, each with dual channel capability makes its ideal for applications such as heat treatment furnaces, autoclaves and environmental chambers - where often more than one variable needs to be profiled. The 3500 has functionality not normally found in a product of this class and its flexibility in being able to interact with other function blocks makes it a very powerful device.



Infrared clip

Communications to the 3500 can be achieved by using an infrared communications adaptor. Clipping onto the front fascia of the controller this device allows configuration and commissioning to be performed without the need to access the rear terminals of the controller.



Infrared clip connected to the 3504

I/O expander

The I/O expander provides increased programmer functionality by increasing the digital I/O capability and expands the 3500 logic capacity by up to 40 I/O.

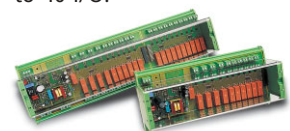

Products designed to integrate

System Integration

Designed to integrate seamlessly with programmable logic controllers and other supervisory control and monitoring systems the 3000 Series provides a unique level of system integration.

By devolving loop control to a 3000 Series controller a PLC is able to concentrate on providing fast and effective logic control without the burden of running complex control algorithms. The 3000 Series controllers also offer better control performance than a PLC, the comfort of single loop integrity and ease of replacement without stopping the process.

A wide range of communication options are catered for by simply plugging in the appropriate module. All units support both RS232 and 2-wire RS485 communicating using the Modbus RTU network protocol. Additionally the 3508 and 3504 support 4-wire RS485 and Profibus DP, DeviceNet® and Modbus TCP network protocols.

Serial Communications

Utilising one of the most common protocols used within the Industrial Automation market, the Eurotherm implementation of Modbus RTU is based on a fixed address table. Parameter addresses are fixed and do not move depending on how the unit is configured making communication to intelligent masters very easy to accomplish.

Modbus Master

The 3500 provides the facility to broadcast one parameter using Modbus RTU to a number of slave units. Typically this would be used to retransmit a Setpoint to other slave zones within a furnace.

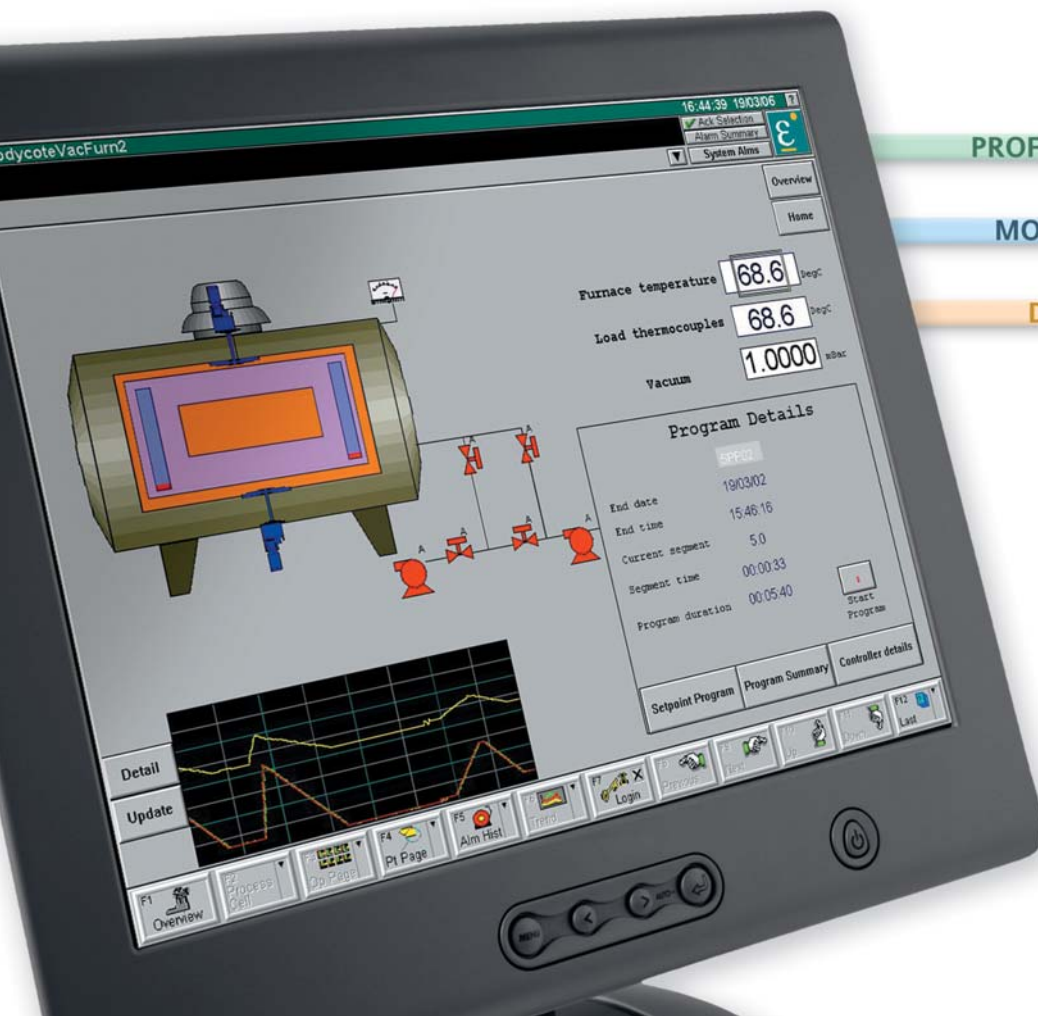

Industry
Standard PLC



PROFIBUS DP

MODBUS TCP (ETHERNET)

DEVICENET

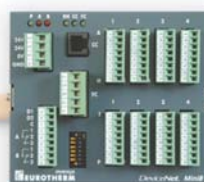

A powerful system tool

Fieldbus Networks

Profibus and DeviceNet are used extensively to communicate to Siemens and Allen Bradley programmable logic controllers.

The 3500 range can easily be integrated in machines where loop controllers are required to act as slaves to a PLC.

Using a PC editor the Profibus GSD file required for the PLC can quickly be created by simply selecting parameters from a pick list.

When using DeviceNet the 3500 EDS file can be registered and the parameter input and output tables edited using Allen Bradley's RSNNetWorx™ configuration tools.

Ethernet Connectivity

Utilising the popular Modbus TCP network protocol the 3500 controllers can be connected to an Ethernet network. This enables plug and play connection to other Eurotherm products such as graphic recorders and third party PLCs or SCADA.

EUROTHERM

3000
SERIES CONTROLLERS...

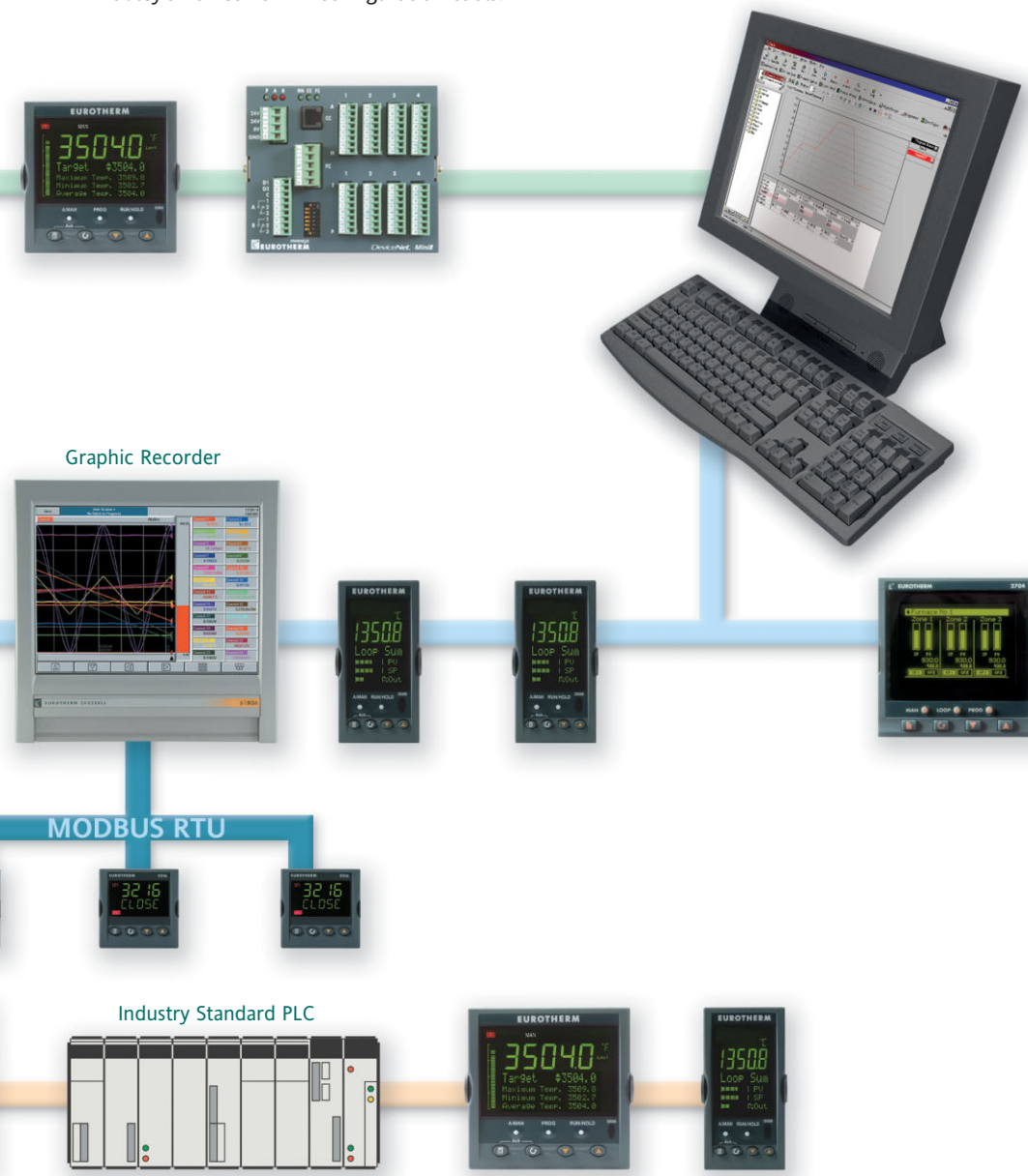

Real-world applications

Whether its for excellence in control, ease of use or its flexible and creative solutions, the 3000 Series can be used in many applications to solve problems and save time and money.



RECIPES

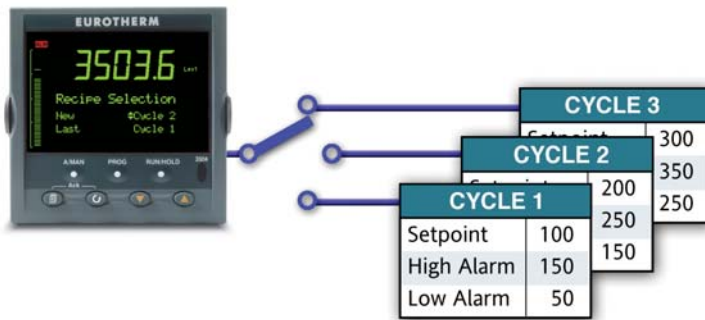

The 3000 recipe function is unique in a controller of this class. Recipes can be stored under a user-defined name to recall a number of parameter settings. These settings may include operating variables or configuration parameters, providing a very powerful means of altering the set up of a controller in a single operation. Recipes may be recalled either from the HMI, over the communications link, or using digital inputs.

TIMER

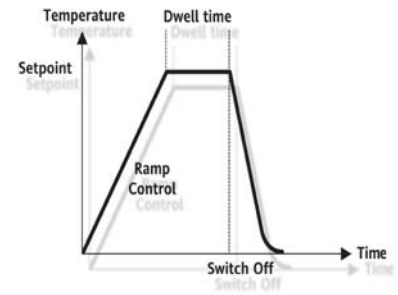

The simple timer in the 3200 may be used to control batch operations, eg food ovens, sterilisers, fryers. Ideal for any application requiring a single dwell at the end of either a controlled ramp or natural approach to setpoint without the need for an additional timing device.

MESSAGES



The HMI on 3000 Series controllers are customisable to show plant information in the format that is most useful for the operator. Customisable scrolling text can indicate event and alarm conditions, to trigger another function, or instruct an operator of the current state of the process. The 3500 has additional facilities to enable a user to design their own user interface.

HEATER FAILURE DETECTION

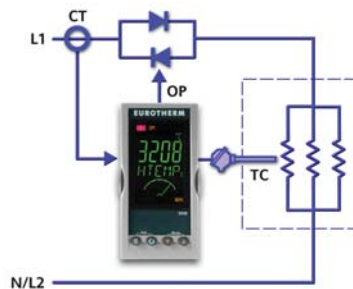

A current transformer input in the 3200 measures the current switched through the load. The measurement is filtered so that the on current and off currents can be separated. From this it is possible to diagnose several load faults including partial load failure, over current and an SSR fault. Typical applications include plastic extrusion, laboratory ovens and other applications where early indication of heater failure can save energy and rework costs.

PROGRAMMER

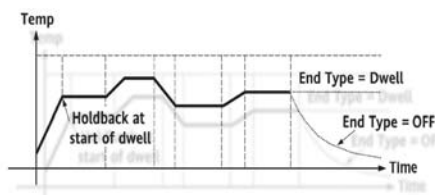

Many applications need to vary temperature, or other process values, with time. The setpoint is varied by using a setpoint program. The program is stored as a series of 'ramp' and 'dwell' segments. All 3000 Series controllers provide this feature. The 3200 has an extremely easy to use 8 segment programmer for simple applications while the 3500 has a very flexible dual channel programmer with storage for 50 programs. The 3500 is ideal for furnace, environmental chamber and autoclave applications that require greater flexibility.

FEEDFORWARD

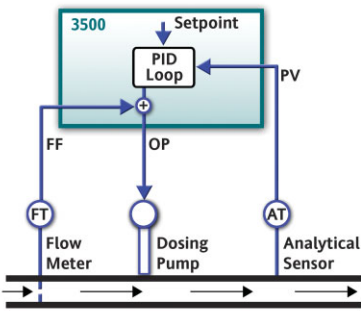

Feedforward is a control technique used to compensate for future disturbances or process changes. It provides an offset on the controller PID calculation to ensure that corrective action is taken to prevent the measured PV being disturbed. A typical application is additive dosing. By measuring the flow rate upstream from the dosing pump it is possible to use the feedforward feature of the 3500 to achieve an output proportional to the fluid flow rate. This means that the dosing rate immediately tracks any changes in flow rate and so prevents any possibility of dangerous over dosing.

ZIRCONIA



The zirconia block calculates carbon potential, oxygen concentration and dew point based on the temperature and probe mV measurements from a zirconia oxygen probe. Probe burn-off sequence and diagnostic alarms are also available to help extend the life of the probe and predict impending probe failure while minimising downtime and rework. This feature enables the 3500 to be used to control carbon potential in an atmosphere furnace, an inert atmosphere in a sintering furnace and dewpoint in an endothermic generator.

DUAL LOOP

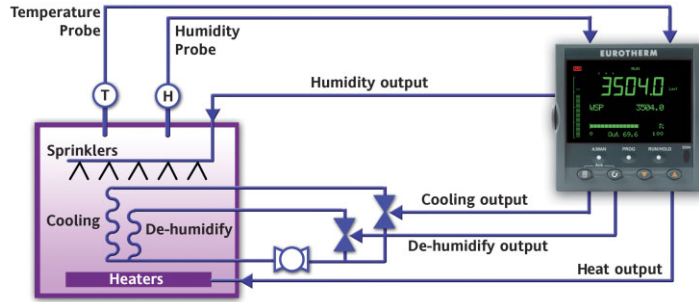

The Dual Loop capability in the 3500 makes it ideal for controlling interactive processes such as those found in carburising furnaces, environmental chambers, autoclaves and fermenters. All of these applications require control and often setpoint programming of

two variables. By using the advanced maths and logic functions within the 3500, intelligent control strategies can be created to compensate for interactive effects between variables and maintain them at setpoint.

DUAL VALVE POSITIONING

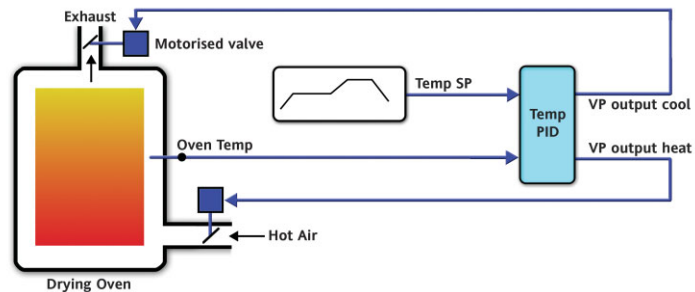

The Dual Valve Positioning (VP) feature on the 3500 allows two motorised valves to be modulated from one controller. Typically one valve would actuate a burner or hot air inlet and the other a cooling damper. This feature removes the need to interface the controller via external positioners.

The VP feature can be used with or without a feedback potentiometer and can also be used with PID in either control channel to provide control strategies such as PID Heat/VP Cool.

MASTER COMMS BROADCAST

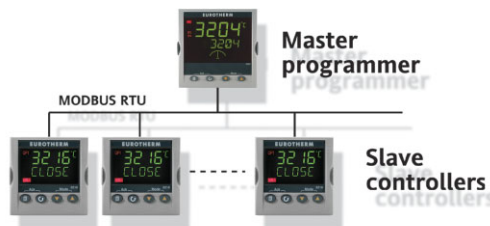



In all 3000 Series controllers it is possible to use the Modbus RTU communication link to send a value, (often setpoint) from one controller to a network of slave devices - providing the economical creation of multi-zone temperature control solutions.

TRANSDUCER SCALING

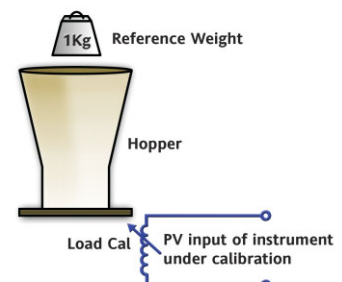
User calibration can be performed in all 3000 Series controllers. The 3200 provides a simple two point calibration on its input and the 3500 has a comprehensive set of transducer scaling options that make it ideal for melt pressure, load cell or comparison type calibrations.



Selection guide and technical specifications

	 3216	 3208	 32h8
Panel Sizes	1/16 (48mm x 48mm)	1/8 (48mm x 96mm)	1/8 Horizontal (96mm x 48mm)
IP Rating	IP65, NEMA 4X	IP65, NEMA 4X	IP65, NEMA 4X
Display Type	4 Digit LCD plus 5 digit alphanumeric	4 Digit LCD plus 5 digit alphanumeric, ammeter display	4 Digit LCD plus 5 digit alphanumeric
Supply Voltage	100 - 264Vac, 24Vac/dc	100 - 264Vac, 24Vac/dc	100 - 264Vac, 24Vac/dc
Control Loops	1	1	1
Input Types	TC, RTD, mV, mA, CT	TC, RTD, mV, mA, CT	TC, RTD, mV, mA, CT
PV Accuracy	Better than 0.25% of reading	Better than 0.25% of reading	Better than 0.25% of reading
Control Types	On/Off, PID, VP	On/Off, PID, VP	On/Off, PID, VP
Output Types	Logic, relay, triac, analogue	Logic, relay, triac, analogue	Logic, relay, triac, analogue
No of Alarms	4	4	4
Alarm Types	Hi, Lo, Dev, Event, SBR	Hi, Lo, Dev, Event, SBR	Hi, Lo, Dev, Event, SBR
Setpoint Programmer	1 Program, 8 segments, 1 event	1 Program, 8 segments, 1 event	1 Program, 8 segments, 1 event
Max Analogue IO	Input	2	2
	Output	2	3
Max Digital IO	Input	2	3
	Output	3	4
Digital IO Expander			
Heater Failure Detection	Yes	Yes	Yes
Recipes	5 with 38 tags	5 with 38 tags	5 with 38 tags
Custom Messages	Yes	Yes	Yes
Custom Pages	Operator list	Operator list	Operator list
Remote Setpoint	mA, Volts	mA, Volts	mA, Volts
Slave Communications	Modbus RTU	Modbus RTU	Modbus RTU
Master Communications	1 Parameter broadcast	1 Parameter broadcast	1 Parameter broadcast
Maths Equations			
Combinational Logic			
Timers	1	1	1
Counters			
Totalisers			
Real Time Clock			
Feedforward			
Melt Pressure			
Carbon Potential			
Humidity			
User Calibration	2 Point on PV	2 Point on PV	2 Point on PV



3204



3508



3504

1/4 (96mm x 96mm)	1/8 (48mm x 96mm)	1/4 (96mm x 96mm)
IP65, NEMA 4X	IP65, NEMA 4X	IP65, NEMA 4X
4 Digit LCD plus 5 digit alphanumeric, ammeter display	Large 4 1/2 digit LCD with 4 x 10 character text	Large 5 digit LCD with with 4 x 20 character text
100 - 264Vac, 24Vac/dc	100 - 264Vac, 24Vac/dc	100 - 264Vac, 24Vac/dc
1	2	2
TC, RTD, mV, mA, CT	TC, RTD, mV, mA, Volts, O2	TC, RTD, mV, mA, Volts, O2
Better than 0.25% of reading	Better than 0.1% of reading	Better than 0.1% of reading
On/Off, PID, VP	On/Off, PID, VP, Dual VP	On/Off, PID, VP, Dual VP
Logic, relay, triac, analogue	Logic, relay, triac, analogue	Logic, relay, triac, analogue
4	8	8
Hi, Lo, Dev, Event, SBR	Hi, Lo, Dev, Event, SBR	Hi, Lo, Dev, Event, SBR
1 Program, 8 segments, 1 event	50 Programs, 500 segments, 8 events	50 Programs, 500 segments, 8 events
2	3	5
3	4	9
1	31(with expansion)	40 (with expansion)
4	32(with expansion)	41(with expansion)
Yes	Yes	Yes
5 with 38 tags	8 with 24 tags	8 with 24 tags
Yes	Yes	Yes
Operator list	Operator list and 8 User Pages	Operator list and 8 User Pages
mA, Volts	mA, Volts	mA, Volts
Modbus RTU	Modbus RTU, Modbus TCP, DeviceNet, Profibus DP, EI-Bisync	Modbus RTU, Modbus TCP, DeviceNet, Profibus DP, EI-Bisync
1 Parameter broadcast	1 Parameter broadcast	1 Parameter broadcast
	24 Calculations	24 Calculations
	24 Operations	24 Operations
1	4	4
	2	2
	2	2
	Day & time	Day & time
	Yes	Yes
	Yes	Yes
	Yes	Yes
	Yes	Yes
2 Point on PV	2 Point, shunt, load cell, comparison, auto tare	2 Point, shunt, load cell, comparison, auto tare

Eurotherm: International sales and service

Understanding and providing local support is a key part of Eurotherm's business. Complementing worldwide Eurotherm offices are a whole range of partners and a comprehensive technical support team... to ensure you get a service you will want to go back to.

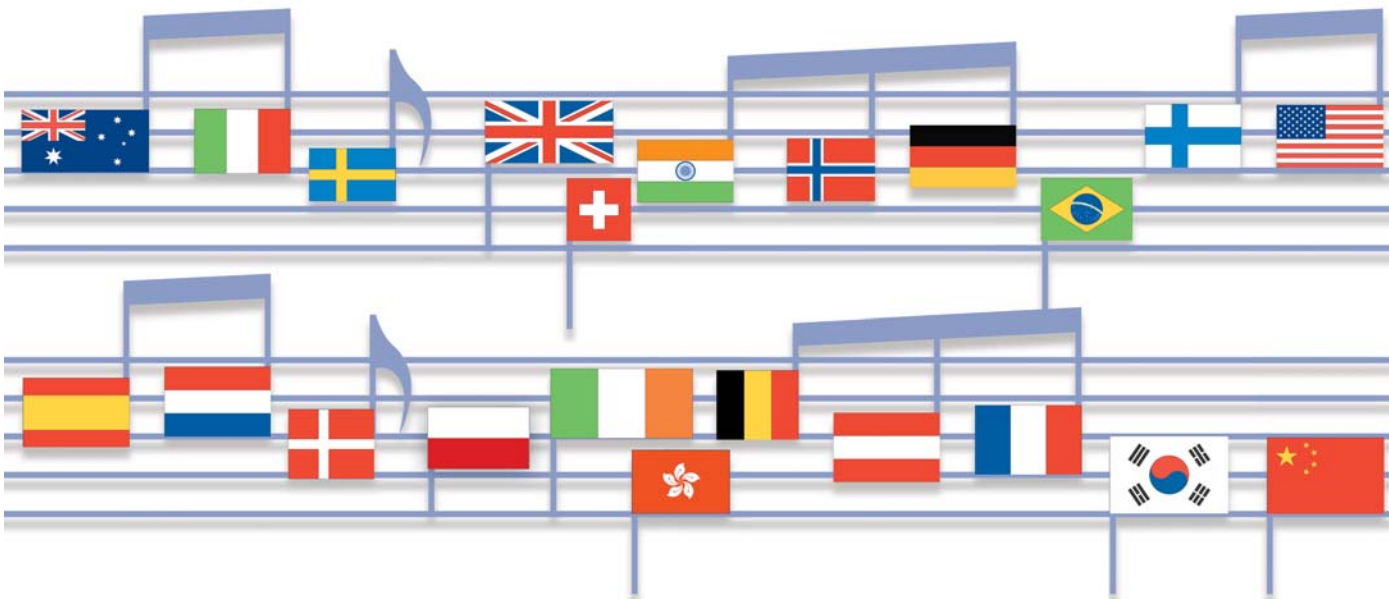

AUSTRALIA Sydney
Eurotherm Pty. Ltd.
T (+61 2) 9838 0099
F (+61 2) 9838 9288
E info.au@eurotherm.com

AUSTRIA Vienna
Eurotherm GmbH
T (+43 1) 7987601
F (+43 1) 7987605
E info.at@eurotherm.com

BELGIUM & LUXEMBOURG Moha
Eurotherm S.A./N.V.
T (+32) 85 274080
F (+32) 85 274081
E info.be@eurotherm.com

BRAZIL Campinas-SP
Eurotherm Ltda.
T (+5519) 3707 5333
F (+5519) 3707 5345
E info.br@eurotherm.com

DENMARK Copenhagen
Eurotherm Danmark AS
T (+45 70) 234670
F (+45 70) 234660
E info.dk@eurotherm.com

FINLAND Abo
Eurotherm Finland
T (+358) 22506030
F (+358) 22503201
E info.fi@eurotherm.com

FRANCE Lyon
Eurotherm Automation SA
T (+33 478) 664500
F (+33 478) 352490
E info.fr@eurotherm.com

GERMANY Limburg
Eurotherm Deutschland GmbH
T (+49 6431) 2980
F (+49 6431) 298119
E info.de@eurotherm.com

HONG KONG & CHINA
Eurotherm Limited North Point
T (+85 2) 28733826
F (+85 2) 28700148
E info.hk@eurotherm.com

Guangzhou Office
T (+86 20) 8755 5099
F (+86 20) 8755 5831
E info.cn@eurotherm.com

Beijing Office
T (+86 10) 6567 8506
F (+86 10) 6567 8509
E info.cn@eurotherm.com

Shanghai Office
T (+86 21) 6145 1188
F (+86 21) 6145 1187
E info.cn@eurotherm.com

INDIA Chennai
Eurotherm India Limited
T (+91 44) 24961129
F (+91 44) 24961831
E info.in@eurotherm.com

IRELAND Dublin
Eurotherm Ireland Limited
T (+353 1) 4691800
F (+353 1) 4691300
E info.ie@eurotherm.com

ITALY Como
Eurotherm S.r.l.
T (+39 31) 975111
F (+39 31) 977512
E info.it@eurotherm.com

KOREA Seoul
Eurotherm Korea Limited
T (+82 31) 2738507
F (+82 31) 2738508
E info.kr@eurotherm.com

NETHERLANDS Alphen a/d Rijn
Eurotherm B.V.
T (+31 172) 411752
F (+31 172) 417260
E info.nl@eurotherm.com

NORWAY Oslo
Eurotherm A/S
T (+47 67) 592170
F (+47 67) 118301
E info.no@eurotherm.com

POLAND Katowice
Invensys Eurotherm Sp z o.o.
T (+48 32) 2185100
F (+48 32) 2177171
E info.pl@eurotherm.com

SPAIN Madrid
Eurotherm España SA
T (+34 91) 6616001
F (+34 91) 6619093
E info.es@eurotherm.com

SWEDEN Malmo
Eurotherm AB
T (+46 40) 384500
F (+46 40) 384545
E info.se@eurotherm.com

SWITZERLAND Wollerau
Eurotherm Produkte (Schweiz) AG
T (+41 44) 7871040
F (+41 44) 7871044
E info.ch@eurotherm.com

UNITED KINGDOM Worthing
Eurotherm Limited
T (+44 1903) 268500
F (+44 1903) 265982
E info.uk@eurotherm.com
www.eurotherm.co.uk

U.S.A. Leesburg VA
Eurotherm Inc.
T (+1 703) 443 0000
F (+1 703) 669 1300
E info.us@eurotherm.com
www.eurotherm.com

Eurotherm is also represented in the following countries:

Algeria	Malaysia
Azerbaijan	Mali
Bahrain	Mexico
Bangladesh	New Zealand
Benin	Niger
Bosnia and Herzegovina	Nigeria
Bulgaria	Oman
Burkina Faso	Pakistan
Cameroon	Philippines
Canada	Puerto Rico
Czech Republic	Qatar
Egypt	Romania
Georgia	Russia
Greece	Saudi Arabia
Guinea-Conakry	Serbia and Montenegro
Hungary	Singapore
Indonesia	Slovak Republic
Iran	Slovenia
Iraq	South Africa
Israel	Sri Lanka
Ivory Coast	Thailand
Japan	Togo
Jordan	Tunisia
Kazakhstan	Turkey
Kenya	Turkmenistan
Kuwait	UAE
Latvia	Ukraine
Lithuania	Uzbekistan

ED53

Represented by:

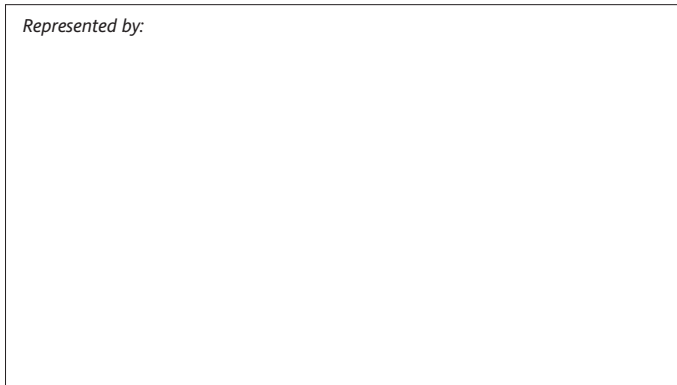

© Copyright Eurotherm Limited 2007

Invensys, Eurotherm, the Eurotherm logo, Chessell, EurothermSuite, Mini8, Eycan, Eyris and Wonderware are trademarks of Invensys plc, its subsidiaries and affiliates. All other brands may be trademarks of their respective owners.

All rights are strictly reserved. No part of this document may be reproduced, modified, or transmitted in any form by any means, nor may it be stored in a retrieval system other than for the purpose to act as an aid in operating the equipment to which the document relates, without the prior written permission of Eurotherm limited.

Eurotherm Limited pursues a policy of continuous development and product improvement. The specifications in this document may therefore be changed without notice. The information in this document is given in good faith, but is intended for guidance only.

Eurotherm Limited will accept no responsibility for any losses arising from errors in this document.

Part No. HA028000 Issue 4



Printed on recycled paper in England 01.07