

# 2108i Temperature/Process Indicator and Alarm Unit



**EUROTHERM  
CONTROLS**

## Installing and Operating Instructions

Thank you for choosing the 2108i indicator and alarm unit. This indicator may be supplied in three hardware variants:

- Indicator only - providing accurate measurement and display of temperature and other process variables. In this case the alarm relays are not fitted.
  - Indicator plus one alarm relay
  - Indicator plus two alarm relays
- Providing outputs for machine and product protection.

### Identification Labels

The indicator is identified by a label fixed to the top of the case which gives the serial number and ordering code. The ordering code defines the configuration of your particular indicator. Details of the code are given on page 7.

### DISPLAY UNITS LABEL SET

A peel-off label set, illustrated below, is supplied with the indicator. If a unit label is required, a convenient position is to fix it to the top right hand corner of the display, as shown.

°C	°F	K	kPa	V	mV
m/s	cm/s	l/h	mWG	A	mA
x10	1x10	l/min	T/h	%	%RH
p.s.i	bar	mbar	mPas	%pH	pH
p.s.i.x10	mmHg	Kg/cm <sup>2</sup>	gal/min	rev/min	mile/h
EUROTHERM					Amps

### DIMENSIONS AND INSTALLATION

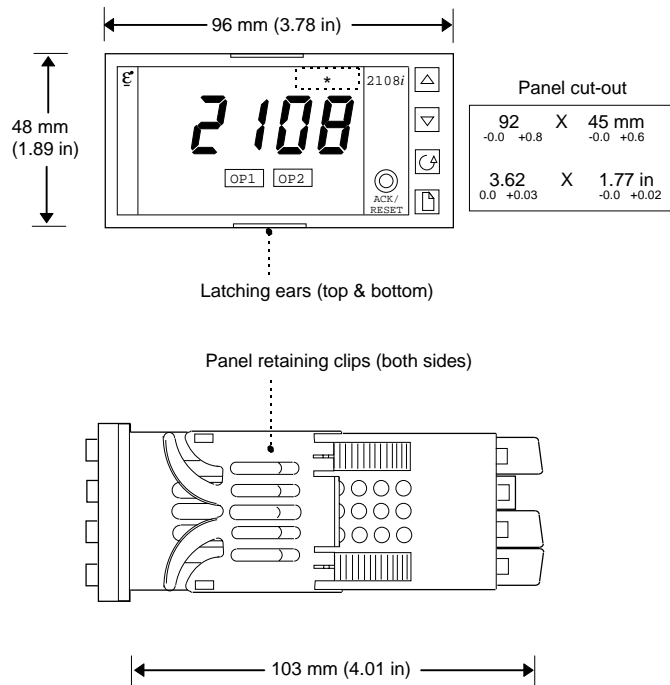

### To install the indicator

Please read the safety information on pages 7 & 8 before proceeding.

- Prepare the panel cut-out to the size shown.
- Insert the indicator through the cut-out.
- Spring the panel retaining clips into place. Secure the indicator in position by holding it level and pushing both retaining clips forward.
- Peel off the plastic film protecting the front of the indicator.

### Unplugging the indicator

The indicator can be unplugged from its sleeve by easing the latching ears outwards and pulling it forward out of the sleeve. When plugging the indicator back into its sleeve, ensure that the latching ears click into place to maintain the IP54 sealing.

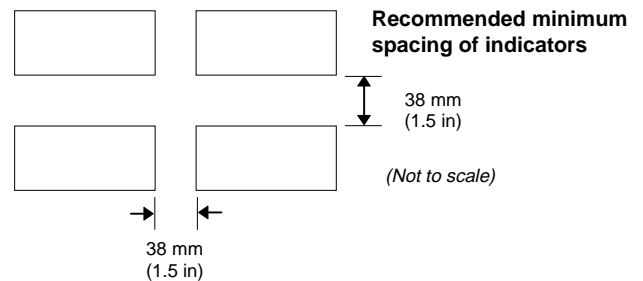

### ELECTRICAL CONNECTIONS

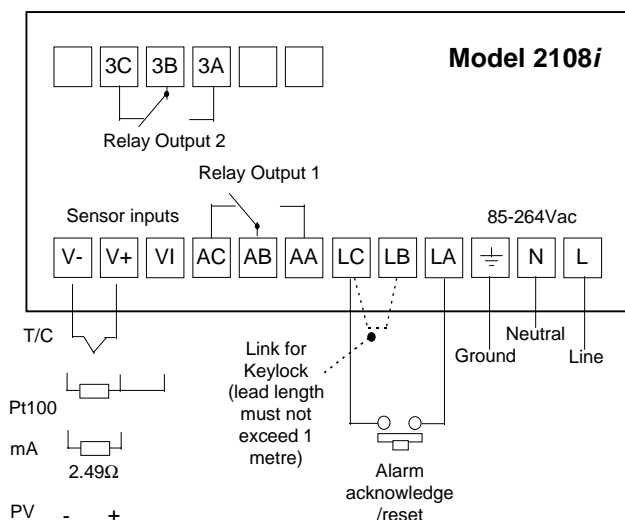

### Relay Ratings

2A, 264Vac resistive

### Wire Sizes

The screw terminals accept wire sizes from 0.5 to 1.5 mm (16 to 22 AWG). Hinged covers prevent hands or metal making accidental contact with live wires. The rear terminals screws should be tightened to 0.4Nm (3.5lb in).

CE This indicator meets the European directives on safety and EMC



## OPERATION

Switch on the indicator. After a 3 second self-test sequence, you will see the display shown below. It is called the HOME display.

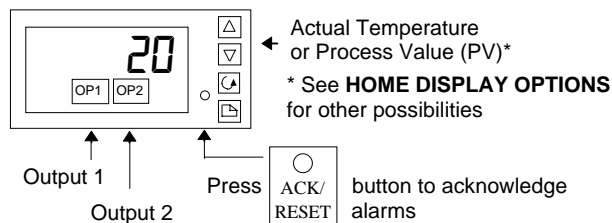

## ALARM INDICATION

There are three internal alarms in the 2108i. They are configurable as high, low or rate of change alarms which alert an operator when a pre-set level (setpoint) has been exceeded. They are flashed as messages in the main display with the following meaning:

Display	Meaning
1---	Alarm 1 is true
2---	Alarm 2 is true
3---	Alarm 3 is true
5br	Sensor Break alarm (open circuit input)

In place of dashes the last three letters indicate the alarm type:  
**FSL** = Full Scale Low alarm,  
**FSH** = Full Scale High alarm,  
**rAL** = Rate of change alarm.  
 If other messages are flashed, see **DIAGNOSTIC ALARMS** on page 4.

Any combination of the four alarms shown in the table above can operate relay outputs 1 & 2. These would normally provide plant safety interlocks or external audio/visual indication. Alarms are assigned to the relay outputs in accordance with the ordering code.

A relay will operate when any alarm attached to it becomes true. The corresponding beacon, OP1 or OP2 will flash when a new alarm occurs and go steady when the ACK/RESET button is pressed. The relay will remain in the alarm state while the alarm condition persists.

Pressing the ACK/RESET button will acknowledge new alarms and reset any latched alarms that are no longer true.

## TO VIEW THE DISPLAY UNITS

In addition to the label set shown on page 1, the temperature units for thermocouple and RTD inputs, are flashed in the main display, as follows:

Press and quickly release the or button. The display units will be flashed for 0.5sec

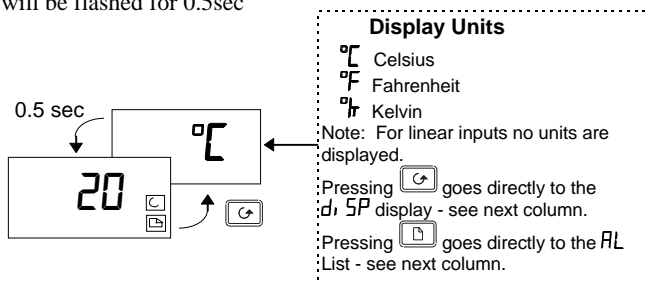

If, at any time you get lost, pressing and together will always return you to the HOME display.  
 If, at any time, no key is pressed within 45 seconds, the display will always return to the HOME display.

## HOME DISPLAY OPTIONS

When shipped from the factory the HOME display will, by default, show the measured temperature (or PV). You can select alternative HOME displays as follows:

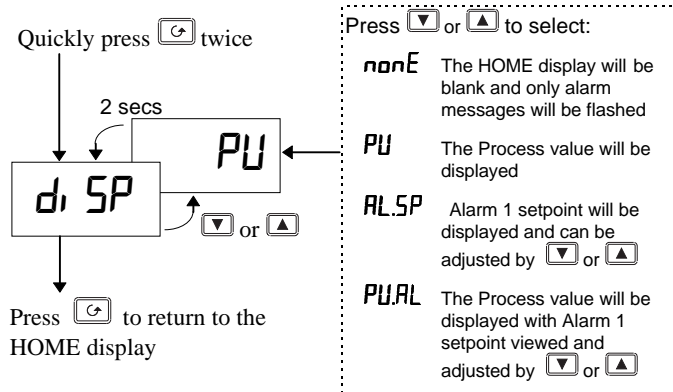

To prevent an Operator changing this option, see **TO HIDE, REVEAL AND PROMOTE PARAMETERS** Page 4.

## TO CHANGE THE ALARM SETPOINTS (TRIP LEVELS)

The button steps through parameter list headings as shown on page 3. The first list is the alarm setpoints list **AL**.

Quickly press twice to choose the **AL** list.

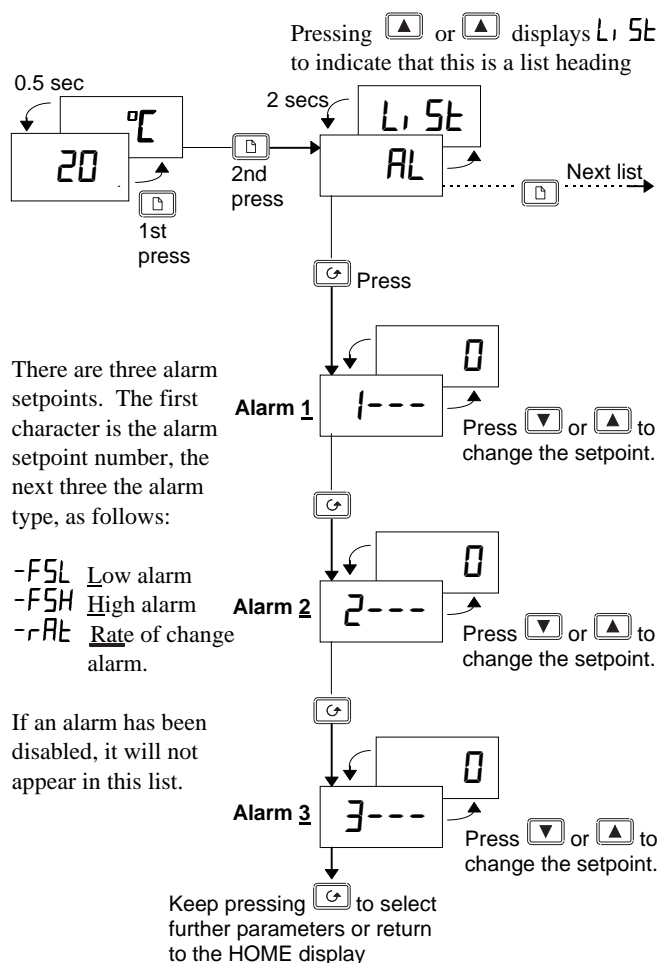

Note: The other parameters listed on page 3 are accessed and adjusted in exactly the same way as this example.

## PARAMETER LISTS

Use these lists to change:

- The alarm setpoints (as shown on the previous page)
- The alarm setpoint limits
- The input filter time constant
- User calibration.

The diagram shows the full list of possible parameters. Some may not appear, however, because they are dependant upon the configuration of the indicator.

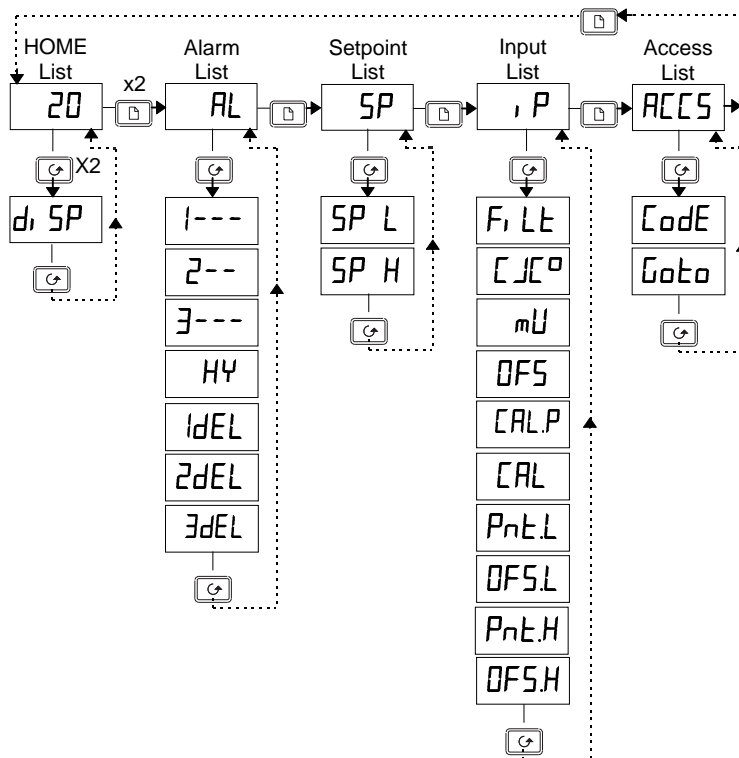

### To Select or change parameters

1. Press to step across the list headings.
2. Press to step down the parameters within a particular list. You will eventually return to the list heading.
3. Press to view the value of a selected parameter. Keep pressing to decrease the value.
4. Press to view the value of a selected parameter. Keep pressing to increase the value.

## PARAMETER TABLES

HOME	Home List	Selectable options	Default setting	Customer setting
d1 SP	HOME display options	See <b>HOME DISPLAY OPTIONS</b> page 2	PU	

AL	Alarm setpoints	Adjustable Range	Default setting	Customer setting
1---	Alarm 1 setpoint	Between low and high setpoint limits.	0	
2---	Alarm 2 setpoint	Note: If the alarm is disabled, the parameter will not appear.	0	
3---	Alarm 3 setpoint		0	
HY	Alarm Hysteresis Prevents relay 'chatter' by setting a difference between relay turn ON and relay turn OFF value	1 to 9999 display units	1	
1dEL	Alarm 1 delay	Used to ignore transient alarms. Alarms must be true for the set time before they become active	OFF to 999.9 seconds	0
2dEL	Alarm 2 delay		OFF to 999.9 seconds	0
3dEL	Alarm 3 delay		OFF to 999.9 seconds	0

\*In place of dashes, the last three letters indicate the alarm type: FSL = Low alarm. FSH = High alarm. rAL = Rate of change alarm

SP	Setpoint limits	Adjustable Range	Default setting	Customer setting
SP L	Alarm setpoint low limit	Prevents alarms from being set out of range	Between Process Value min and max	As order code else PV min & max
SP H	Alarm setpoint high limit			

i P	Input List	Adjustable Range	Default setting	Customer setting
FiLt	Input filter time constant Reduces display flicker due to process noise.	OFF to 999.9 seconds	1.6	
CJC	Cold junction compensation temperature ( T/C inputs only) measured at the rear terminals.		Read-only	Read-only
mV	mV input measured at the rear terminals		Read-only	Read-only
OFFS	PV offset Customer set fixed calibration offset which applies over the whole display range	- 1999 to 9999 display units	0	
CALP	Calibration password (See <b>USER CALIBRATION</b> )	0 to 9999	3	
CAL	Calibration type.	FACT Restores Factory calibration USER User calibration applies	FACT	
PntL	Low calibration point	These parameters appear only if USER calibration selected	- 1999 to 9999 display units	0
OFFSL	Low point offset		- 1999 to 9999 display units	0
PntH	High calibration point		- 1999 to 9999 display units	100
OFFSH	High point offset		- 1999 to 9999 display units	0

ACC5	Access list	Used for re-configuring the indicator. See the next page for details
------	-------------	--

## TO HIDE, REVEAL AND PROMOTE PARAMETERS

### The *Pro* (Promote) option

Up to twelve commonly used parameters can be 'promoted' into the HOME list. This will give the operator quick access to them by simply pressing the  button. This feature, used in combination with 'hide' and 'read only', allows you to organise the way in which you want your indicator formatted.

Select EDIT level to hide, reveal or promote parameters as below:

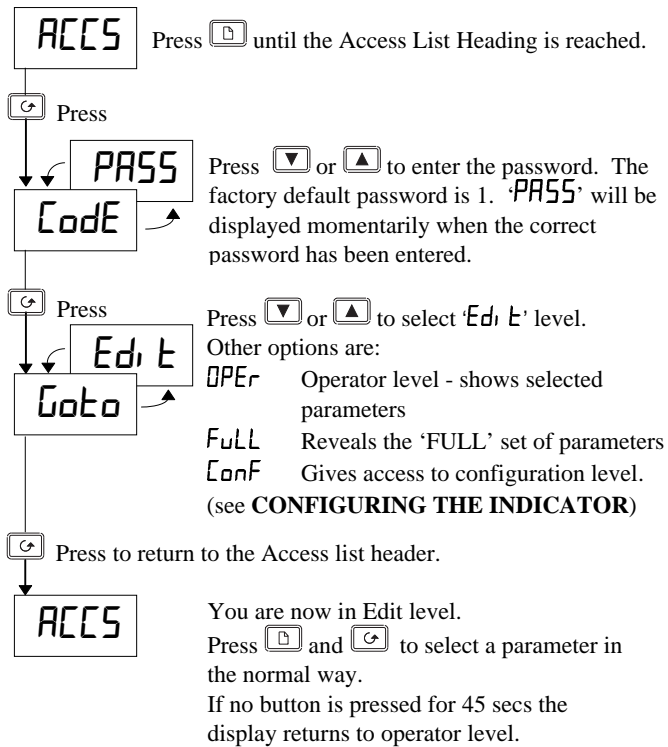

### Edit Level Example:

High alarm 2 has been selected.

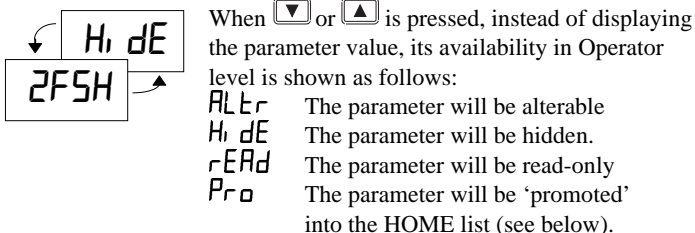

### Promote Level Example:

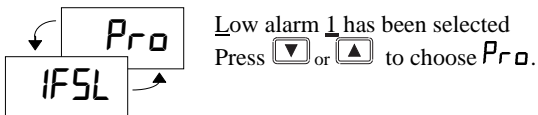

The parameter *IFSL* will now appear in the HOME list. Repeat the procedure for any other parameters you wish to promote. To de-promote a parameter go to *Edit* level, select the parameter from the relevant list and change the choice from *Pro* back to *ALtr*, *rEAd* or *Hi dE*.





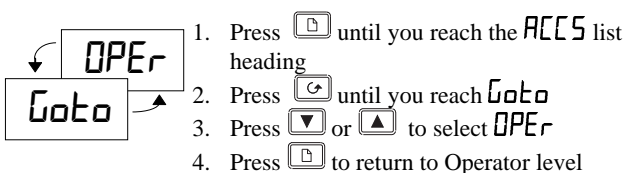







### Returning to Operator level

Repeat the above procedure for all the parameters you wish to hide, promote, or make read-only then return to operator level:



## USER CALIBRATION

Your indicator has been calibrated for life against known reference sources in the factory. User calibration allows you to apply offsets to compensate for sensor and other system errors. You can apply a simple fixed offset over the whole display range using the parameter *OFFS* in the *P* list, or alternatively, you may apply a 2-point calibration as follows:

- Press  until you reach the *P* list
- Press  until you reach the *CAL.P* parameter
- Press  or  to enter the password. The factory default password is 3. *PASS* will be displayed when correct.
- Press  to reach the *CAL* parameter
- Press  or  to select *USER* (*FACT* will restore the factory calibration)
- Press  to select *PntL*
- Press  or  to adjust the value at which you wish to apply the low calibration point offset. (eg zero)
- Press  to select *OFFSL*
- Press  or  to set the low calibration point offset.
- Repeat the above to select and adjust *PntH* and *OFFSH*

The graph below shows the effect of a low and high point offset.

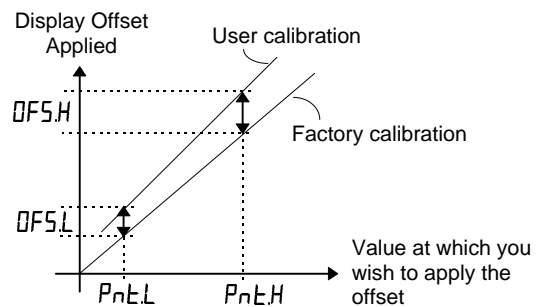

## DIAGNOSTIC ALARMS

These warn that a fault exists in either the indicator or the connected devices.

Alarm	What it means	What to do about it
EE.Er	<i>Electrically Erasable Memory Error</i> : The value of an operator or configuration parameter has been corrupted.	This fault will automatically take you into configuration level. Check all of the configuration parameters before returning to operator level. Once in operator level, check all of the operator parameters before resuming normal operation. If the fault persists or occurs frequently, contact Eurotherm Controls.
S.br	<i>Sensor Break</i> : Input sensor is open circuit.	Check that the sensor is correctly connected.
LLLL	<i>Out of range low reading</i>	Check the value of the input
HHHH	<i>Out of range high reading</i>	Check the value of the input
Err1	<i>Error 1: ROM self-test fail</i>	Return the indicator for repair
Err2	<i>Error 2: RAM self-test fail</i>	Return the indicator for repair
Err3	<i>Error 3: Watchdog fail</i>	Return the indicator for repair
Err4	<i>Error 4: Keyboard failure</i> Stuck button, or a button was pressed during power up.	Switch the power off and then on without touching any of the indicator buttons.

## CONFIGURING THE INDICATOR

### To select configuration level

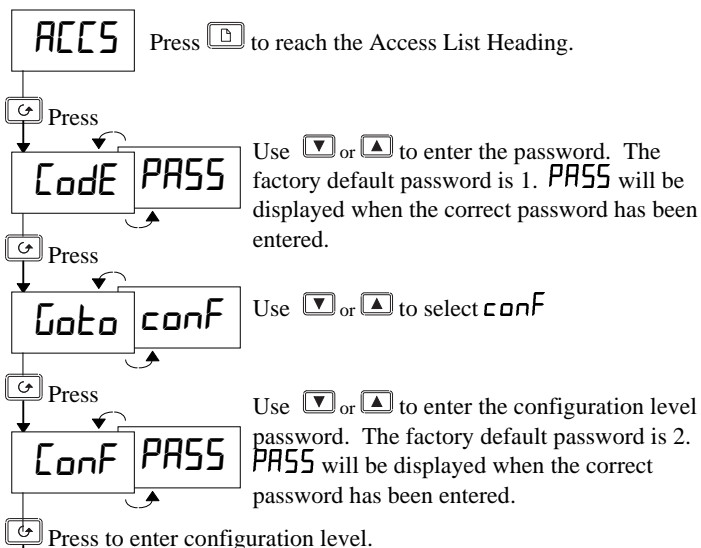

### Select configuration level to change:

- The display units
- The input sensor type
- The scaling of linear inputs
- The alarm configuration
- The relay output configuration
- The passwords.

### To Exit Configuration level

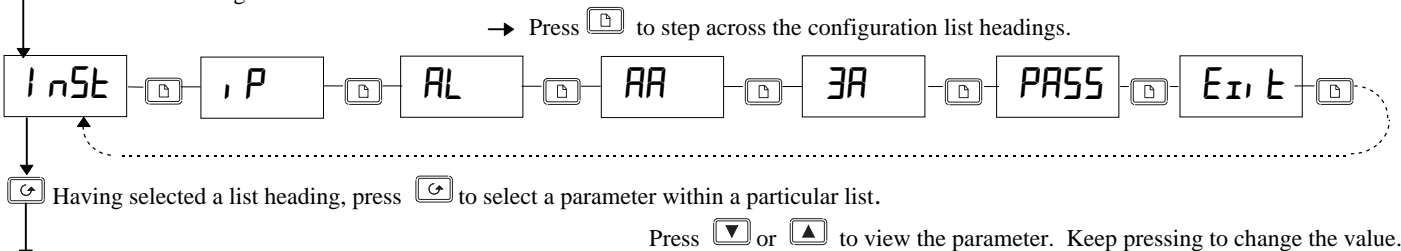
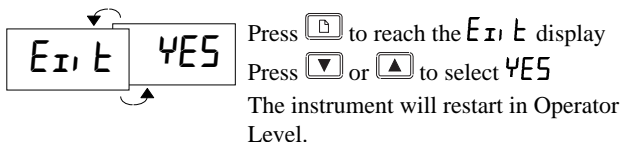

<i>INST</i>	Instrument configuration list	Options	Meaning	Default setting	Customer setting
<i>units</i>	Display <u>units</u>	<i>C</i> <i>F</i> <i>K</i> <i>none</i>	<u>C</u> elsius <u>F</u> ahrenheit <u>K</u> elvin <u>N</u> one (for linear inputs)	Defined by the ordering code, otherwise <i>C</i>	
<i>decP</i>	<u>D</u> ecimal <u>p</u> laces in display	<i>none</i> <i>one</i> <i>two</i>	None One Two	Defined by the ordering code, otherwise <i>none</i>	
<i>Ac.bu</i>	Front panel <u>A</u> ck/ <u>R</u> eset <u>b</u> utton enable	<i>YES</i> <i>no</i>	<i>YES</i> = Button enabled <i>no</i> = Button disabled	<i>YES</i>	

<i>IP</i>	Sensor Input configuration list	Options	Meaning	Default setting	Customer setting
<i>input</i>	<u>I</u> nterface type  NOTE: <i>After selecting an input type, do not forget to adjust the setpoint limits in Full Access level.</i>	<i>Jtc</i> <i>Ktc</i> <i>Ltc</i> <i>Rtc</i> <i>Btc</i> <i>Ntc</i> <i>Itc</i> <i>Stc</i> <i>PL 2</i> <i>rtd</i> <i>Ctc</i> <i>mV</i>	<u>J</u> thermocouple <u>K</u> thermocouple <u>L</u> thermocouple <u>R</u> thermocouple <u>B</u> thermocouple <u>N</u> thermocouple <u>I</u> thermocouple <u>S</u> thermocouple <u>P</u> latinell <u>I</u> 100Ω Platinum resistance thermometer <u>C</u> ustom input C thermocouple = default* Linear <u>m</u> illi <u>v</u> olt	Defined by the ordering code otherwise <i>Ktc</i>  * If a different custom input is supplied, <i>Ctc</i> will be replaced by the table reference number listed on page 7, <b>Ordering Code</b>	
<i>CJC</i>	<u>C</u> old junction <u>c</u> ompensation ( <i>CJC</i> does not appear for <i>mV</i> or <i>rtd</i> inputs. For <i>mV</i> see 'Linear input scaling' on page 6)	<i>Auto</i> <i>0°C</i> <i>45°C</i> <i>50°C</i>	<u>A</u> utomatic <u>0</u> °C external reference <u>45</u> °C external reference <u>50</u> °C external reference	<i>Auto</i>	
<i>imp</i>	Sensor break input <u>i</u> mpedance threshold	<i>OFF</i> <i>Auto</i> <i>H1</i> <i>H1 H1</i>	No sensor break (linear inputs only) 1.5KΩ 5KΩ 15KΩ If the sensor input exceeds this value, the sensor break alarm will be activated.	<i>Auto</i>	

..... Continued on the next page

**Linear input scaling (-9.99 to +80.00mV).** These parameters appear after  $i n P L$  whenever a linear mV input is configured. This allows the low and high displayed values to be set up against the corresponding mV inputs.

			Displayed value	Default setting	Customer setting
$i n P L$	mV <u>input low</u>			0	
$i n P H$	mV <u>input high</u>			50	
$U A R L L$	Displayed <u>value low</u>			0	
$U A R L H$	Displayed <u>value high</u>			50	

**Alarm Configuration**

**Alarms** are used to alert an operator when a pre-set level or condition has been exceeded. They are normally used to switch a relay output - to provide interlocking of the machine or plant or external audio or visual indication of the condition.

The  $R L$  list configures the three internal ‘soft’ alarms and causes the appropriate alarm message to be flashed in the HOME display.

**Soft Alarms** are a visual warning message within the indicator. To attach a soft alarm to activate a relay see ‘**Relay outputs 1 and 2 Configuration**’.

$R L$	<u>Alarm type conf</u>	Options	Meaning	Default setting	Customer setting
$R L 1$	<u>Alarm 1 type</u>	OFF FSL FSH rAL rAS	The alarm is disabled Full Scale Low alarm The PV exceeds a set low level Full Scale High alarm The PV exceeds a set high level Rate of change, -1999 to 1999 display units per min. 0 = OFF Rate of change, -1999 to 1999 display units per sec. 0 = OFF	$R L 1$ , $R L 2$ , and $R L 3$ As order code, otherwise OFF	Alarm number 1 2 3
$L t c h$	<u>Alarm latching</u>	no YES mAn	Non-latching Latched with automatic resetting (Note 1) Latched with <u>man</u> ual resetting (Note 2)	As order code, otherwise no	
$b l o c$	<u>Alarm blocking</u>	no YES	No blocking Blocked until first good. (Note 3)	no	

The above sequence is repeated for:  $R L 2$  (alarm 2) and  $R L 3$  (alarm 3)

Notes:

1. Automatic resetting means that, once the alarm has been acknowledged, it will automatically clear when it is no longer true.
2. Manual resetting means that the alarm must first clear before it can be reset.
3. In blocking mode, after power on, the process value must first enter a good state before the alarm becomes active. This is particularly useful for low alarms which can be ‘blocked’ while the process is warming up.

**Relay outputs 1 and 2 Configuration**

The  $R A$  and  $R A$  lists allow the three internal ‘soft’ alarms to be attached to relay outputs 1 and 2 respectively.

Note:  $R A$  is the terminal number for output 1 and  $R A$  is the terminal number for output 2.

$R A$	<u>Relay output 1 configuration</u>	Options	Meaning	Default setting	Customer setting
$R A$	<u>Relay output 2 configuration</u>			$R A$	$R A$
$i d$	<u>Identity of output</u>	rELY	Relay	rELY	rELY
$F u n c$	<u>Function of output</u>	nonE diG	None Output disabled Digital alarm output	diG	diG
$S e n s$	<u>Sense of the output.</u>	nor inu	Normal (relay energised in alarm) Inverted (relay de-energised in alm)	inu	inu

**To Attach Alarms to the Relay Outputs.**

Any of the following alarms can be combined to operate the selected relay output. Press to select a particular alarm. Press or to select YES if you want it to operate the relay. Select no to disconnect a given alarm.

		Options	Attaching alarms to a relay	Output 1	Output 2	Output 1	Output 2
$1---*$	Alarm 1	YES / no		As order code otherwise no, 5br defaults to YES on both outputs			
$2---*$	Alarm 2	YES / no					
$3---*$	Alarm 3	YES / no					
$5br$	<u>Sensor break alarm</u>	YES / no					
$n w$	New alarm	YES / no					

\* The last three letters will correspond to the alarm type set in the  $R L$  list. If the alarm is disabled,  $R L 1$  or  $R L 2$  or  $R L 3$  will be shown.

**Passwords**

$P A S S$	<u>Passwords configuration</u>	Range	Default setting	Customer setting
$R C C P$	Full and Edit level password	0-9999	1	
$C n F P$	Configuration level password	0-9999	2	
$C A L P$	User calibration password	0-9999	3	

## ORDERING CODE

Model number	Function	Display colour	Supply voltage	Relay Output 1	Relay Output 2	Manual	Sensor input	Range min	Range max	Units	Input Adaptor
2108i	AL		VH					Note 1	Note 1		

Function  
AL Alarm unit

Display colour  
GN Green display  
RD Red display

Supply voltage  
VH 85-264Vac

Relay Output 1  
XX Not fitted  
RF Fitted unconfigured  
**Un latched alarms**  
FH High alarm 1  
FL Low alarm 1  
AL High alarm 1 & low alarm 3  
RA Rate-of -change alarm 1  
**Latched alarms**  
HA High alarm 1  
LA Low alarm 1  
RT Rate-of -change alarm 1  
AA High alarm 1 & low alarm 3  
NW New alarm status

Manual  
XXX None  
ENG English  
FRA French  
GER German  
NED Dutch  
SPA Spanish  
SWE Swedish  
ITA Italian

Relay Output 2  
XX Not fitted  
RF Fitted unconfigured  
**Un latched alarms**  
FH High alarm 2  
FL Low alarm 2  
RA Rate-of -change alarm 2  
**Latched alarms**  
HA High alarm 2  
LA Low alarm 2  
RT Rate-of -change alarm 2  
NW New alarm status

Units  
C °C  
F °F  
K Kelvin  
X Linear input

Sensor input		Range min & max limits	
<b>Thermocouples</b>			
J	Type J	-210 to 1200 °C	-340 to 2192 °F
K	Type K	-200 to 1372	-325 to 2500
T	Type T	-200 to 400	-325 to 750
L	Type L	-200 to 900	-325 to 1650
N	Type N	-200 to 1300	-325 to 2370
R	Type R	-50 to 1768	-58 to 3200
S	Type S	-50 to 1768	-58 to 3200
B	Type B	0 to 1820	32 to 3308
P	Platinell II	0 to 1369	32 to 2496
<b>Resistance thermometer</b>			
Z	Pt100	-200 to 850	-325 to 1562
<b>Custom downloaded inputs</b> "Table Reference Number"			
C	Type C -W5%Re/W26%Re (default downloaded input)	"LC" 0 to 2319	32 to 4200
D	Type D W3%Re/W25%Re	"T035" 0 to 2399	32 to 4350
E	E thermocouple	"T012" -200 to 999	-325 to 1830
1	Ni/Ni18%Mo	"T033" 0 to 1399	32 to 2550
2	Pt20%Rh/Pt40%Rh	"T025" 0 to 1870	32 to 3398
3	Engelhard W/W26%Re	"T09" 0 to 2000	32 to 3632
4	Hoskins W/W26%Re	"T029" 0 to 2010	32 to 3650
5	Engelhard W5%Re/W26%Re	"T011" 10 to 2300	50 to 4172
6	Bucose W5%Re/W26%Re	"T038" 0 to 2000	32 to 3632
7	Pt10%Rh/Pt40%/Rh	"T023" 200 to 1800	392 to 3272
8	Exergen K80 I.R. Pyrometer	"E-80" -45 to 650	-49 to 1202
<b>Linear inputs</b>			
M	-9.99 to +80mV	Scaleable	-1999 to 9999
Y	0 to 20mA(note 2)	Scaleable	-1999 to 9999
A	4 to 20mA (note 2)	Scaleable	-1999 to 9999
V	0 to 10Vdc(note 3)	Scaleable	-1999 to 9999
<b>Special input</b>			
X	Special input		

Input Adaptor  
XX None  
V1 0-10Vdc  
A1 0-20mA sense resistor (2.49Ω. 0.1%)

Note 1: Enter the minimum and maximum display range with the number of decimal places required (up to two). Thermocouple and RTD inputs will always display over the full range shown but the values entered here will be used as low and high alarm setpoint limits. For linear inputs, enter the display readings (with up to two decimal places) corresponding to the minimum and maximum input signal values

Note 2: A 1% 2.49Ω current sense resistor is supplied as standard. If greater accuracy is required a 0.1% resistor can be specified in the input adaptor field.

Note 3: An input adaptor is required - see input adaptor field.

## TECHNICAL SPECIFICATION

Display	4 digit, red or green, 15.9mm high characters
Calibration accuracy	±0.25% of reading, or ± 1°C, or ± 1LSD whichever is the greater
Cold junction compensation	>15 to 1 rejection of ambient temperature change
Panel sealing	IP54
Operating ambients	0 to 55°C. Ensure that the enclosure is adequately ventilated. 5 to 95%RH, non condensing
Storage temperature	-30°C to +75°C.
Atmosphere	Not suitable for use above 2000m or in explosive or corrosive atmospheres
Power supply	100 to 240Vac -15%, +10%, 48 to 62Hz, maximum consumption 5Watts
Relay rating (isolated)	Maximum: 264Vac, 2A resistive. Minimum operating voltage and current: 12Vdc, 100mA
Wire sizes	Use a minimum of 0.5mm <sup>2</sup> or 16awg wire for plant connections.
Over current protection	Use independent 2A fuses for the indicator supply and relay outputs. Suitable fuses are EN60127 (type T)
Acknowledge/keylock input	Open circuit voltage: 22 volts. Nominal short circuit current: 20mA. Non-isolated from PV input.
Electrical safety	Meets EN 61010 (Voltage transients on the power supply must not exceed 2.5kV). Pollution degree 2.
Isolation:	All isolated inputs and outputs have reinforced insulation to protect against electric shock. (See live sensor note)

## SAFETY AND EMC INFORMATION

### Safety

This indicator complies with the European Low Voltage Directive 73/23/EEC, amended by 93/68/EEC, by the application of the safety standard EN 61010.

### Electromagnetic compatibility

This indicator conforms with the essential protection requirements of the EMC Directive 89/336/EEC, amended by 93/68/EEC, by the application of a Technical Construction File. This indicator satisfies the general requirements of the industrial environment defined in EN 50081-2 and EN 50082-2.

## GENERAL

The information contained in these instructions is subject to change without notice. While every effort has been made to ensure the accuracy of the information, Eurotherm Controls shall not be held liable for errors contained herein.

### Unpacking and storage

The packaging should contain the indicator, two panel retaining clips, a 2.49Ω current sense resistor, a peel off label set and this instruction leaflet.

If the packaging or the indicator are damaged, do not install it but contact the company where you purchased the product.

## SERVICE AND REPAIR

This indicator has no user serviceable parts. Contact your nearest Eurotherm Controls agent for repair.

### Caution: Charged capacitors

Before removing the indicator from its sleeve, switch off the supply and wait two minutes to allow capacitors to discharge. Failure to observe this precaution may damage the indicator or cause some discomfort to the user.

### Electrostatic discharge precautions

When the indicator is removed from its sleeve, it is vulnerable to damage by electrostatic discharge from someone handling the indicator. To avoid this, before handling the unplugged indicator discharge yourself to ground.

### Cleaning

Do not use water or water based products to clean labels or they will become illegible. Isopropyl alcohol may be used to clean labels. A mild soap solution may be used to clean other exterior surfaces of the product.

### Safety Symbols

The following safety symbols are used on the controller:



Caution, (refer to the accompanying documents)



Functional earth (ground) terminal

### Personnel

Installation must be carried out by qualified personnel.

### Enclosure of live parts

The indicator must be installed in an enclosure to prevent hands or metal tools touching parts that may be electrically live.

### Caution: Live sensors

The alarm acknowledge/keylock inputs are electrically connected to the sensor input (e.g. thermocouple). In some installations the temperature sensor may become live. The indicator is designed to operate under these conditions, but you must ensure that this will not damage other equipment connected to the acknowledge/keylock inputs and that service personnel do not touch this connection while it is live. With a live sensor, all cables, connectors and switches for connecting the sensor and non-isolated inputs and outputs must be mains rated.

## INTERNATIONAL SALES AND SERVICE

### EUROTHERM CONTROLS LTD

Faraday Close, Durrington, Worthing,  
West Sussex BN13 3PL

Telephone Sales: (01903) 695888

Technical: (01903) 695777

Service: (01903) 695444

Fax (01903) 695666

Countries not listed - enquiries/orders to:  
Eurotherm Controls Limited,  
Export Dept., Faraday Close, Durrington,  
Worthing, West Sussex, BN13 3PL

Telephone (01903) 268500

Fax (01903) 265982

Telex 87114 EUOWG G

### AUSTRALIA

Eurotherm Pty. Ltd.

Telephone Sydney (+61 2) 477 7022

Fax (+61 2) 477 7756

### AUSTRIA

Eurotherm GmbH

Telephone Vienna (+43 1) 798 7601

Fax (+43 1) 798 7605

Telex 047 1132000 EIAUT A

### BELGIUM

Eurotherm B.V.

Telephone Antwerp (+32 3) 322 3870

Fax (+32 3) 321 7363

### DENMARK

Eurotherm A/S

Telephone Copenhagen (+45 31) 871622

Fax (+45 31) 872124

### FRANCE

Eurotherm Automation SA

Telephone Lyon (+33 478) 664500

Fax (+33 478) 352490

Telex 042 380038 EUROTERM F

### GERMANY

Eurotherm Regler GmbH

Telephone Limburg (+49 6431) 2980

Fax (+49 6431) 298119

Telex 041 484791 EUROT D

### HONG KONG

Eurotherm Limited

Telephone Hong Kong (+852) 2873 3826

Fax (+852) 2870 0148

Telex 0802 69257 EIFEL HX

### INDIA

Eurotherm India Limited

Telephone Madras (+9144) 4928129

Fax (+9144) 4928131

### IRELAND

Eurotherm Ireland Limited

Telephone Naas (+353 45) 879937

Fax (+353 45) 875123

### ITALY

Eurotherm SpA

Telephone Como (+39 31) 975111

Fax (+39 31) 977512

Telex 380893 EUROTH I

### JAPAN

Eurotherm Japan Limited

Telephone Tokyo (+81 3) 33702951

Fax (+81 3) 33702960

### KOREA

Eurotherm Korea Limited

Telephone Seoul (+82 2) 5438507

Fax (+82 2) 545 9758

Telex EIKOR K23105

### NETHERLANDS

Eurotherm B.V.

Telephone Leiden (+31 71) 5411841

Fax (+31 71) 5414526

### NEW ZEALAND

Eurotherm Limited

Telephone Auckland (+64 9) 358 8106

Fax: (+64 9) 358 1350

### NORWAY

Eurotherm A/S

Telephone Oslo (+47 66) 803330

Fax (+47 66) 803331

### SPAIN

Eurotherm España SA

Telephone (+34 1) 6616001

Fax (+34 1) 6619093

### SWEDEN

Eurotherm AB

Telephone Malmo (+46 40) 384500

Fax (+46 40) 384545

### SWITZERLAND

Eurotherm Produkte (Schweiz) AG

Telephone Zurich (+41 1) 8103646

Fax (+41 1) 8108920

### UNITED KINGDOM

Eurotherm Controls Limited

Telephone Worthing (+44 1903) 268500

Fax (+44 1903) 265982

### U.S.A

Eurotherm Controls Inc.

Telephone Reston (+1 703) 471 4870

Fax (+1 703) 787 3436

**ENG**

## Wiring

Wire the indicator in accordance with the wiring data given in these instructions. Take particular care not to connect AC supplies to the low voltage sensor input or logic outputs. Only use copper conductors for connections, (except thermocouple). Ensure that the installation complies with local wiring regulations.

## Power Isolation

The installation must include a power isolating switch or circuit breaker that disconnects all current carrying conductors. The device should be mounted in close proximity to the indicator, within easy reach of the operator and marked as the disconnecting device for the indicator.

## Voltage rating

The maximum continuous voltage applied between any connection and ground must not exceed 264Vac.

For the above reason the indicator should not be wired to a three phase supply with an unearthed star connection. Under fault conditions such a supply could rise above 264Vac with respect to ground and the product would not be safe.

## Conductive pollution

Electrically conductive pollution must be excluded from the cabinet in which the indicator is mounted. For example, carbon dust is a form of electrically conductive pollution. Where condensation is likely, for example at low temperatures, include a thermostatically controlled heater in the cabinet.

## Installation requirements for EMC

- For general guidance refer to Eurotherm Controls EMC Installation Guide, HA025464.
- It may be necessary to fit a filter across the relay output to suppress conducted emissions. The filter requirements will depend on the type of load. For typical applications we recommend Schaffner FN321 or FN612.

## Routing of wires

To minimise the pick-up of electrical noise, the sensor input wiring should be routed away from high-current power cables. Where it is impractical to do this, use shielded cables with the shield grounded at both ends.